



Alternators, Starters & Parts

**Why
choose
AS-PL
products?**

See the AS-PL interactive presentation

Company Mission

„Providing top-quality goods tailored to market expectations while using state-of-the-art technologies.“

Strengths

Products	Leader	32 years
OF PREMIUM QUALITY	OF THE INDUSTRY	OF EXPERIENCE

AS-PL Branches

POLAND

Headquarters
AS-PL Sp. z o.o.
ul. Miłobądzka 32
80-714 Góralnia, Poland
t. 011 48 58 304 12 85

Sales Department
AS-PL Sp. z o.o.
Parafianki Park Góralnia 10
ul. Miłobądzka 32 / 80-714 Góralnia, Poland
Sales@as-pl.com
+48 58 304 12 85

Production Plant
AS-PL Sp. z o.o.
ul. Miłobądzka 32
80-714 Góralnia, Poland

Storage capabilities

21 000	15 600	89 700
PALLET PLACES	COMPLETED ORDERS PER MONTH	DIFFERENT PRODUCTS PACKED PER DAY

Standards

We are a leader in the alternator and starter industry. See what this means.

Purchase platform

MODERN PURCHASE PLATFORM

Order when shopping you'll receive orders 24/7, with numerous innovative features for buyers.

Catalogues, certificates and organisations

AS-PL products are present in prestigious catalogues

activities

Selection menu

Click to learn more

Company Mission

„Providing top-quality goods tailored to market expectations while using state-of-the-art technologies.“

offer

remanufacturing

advantages

contact



Products	Leader	32 years
OF PREMIUM QUALITY	OF THE INDUSTRY	OF EXPERIENCE

Strengths



POLAND

Headquarters
AS-PL Sp. z o.o.
ul. Michalski 32
80-716 Gdańsk, Poland
info@as-pl.com
+48 58 304 12 85

Sales Department
AS-PL Sp. z o.o.
Parafianki Park Gdańsk IV,
ul. Elżbiaka 130 / Building no. 2
80-718 Gdańsk, Poland
sales@as-pl.com
+48 58 304 12 85

Production Plant
AS-PL Sp. z o.o.
ul. Skoweczna 53,
83-240 Lubichowo, Poland

AS-PL Branches



	20 000 m ²	
	of storage space	
21 000	15 600	89 700
PALLET PLACES	COMPLETED ORDERS PER MONTH	DIFFERENT PRODUCTS PACKED PER DAY

Storage capabilities



AS
Alternators, Starters & Parts

We are a leader in the alternator and starter industry. See what this means.

Standards



MODERN PURCHASE PLATFORM

Online store allowing you to place orders 24/7, with numerous innovative features for buyers.

Purchase platform



AS
Alternators, Starters & Parts

TecDoc
DATA SUPPLIER

MAM AutoCat v8

TUV Rheinland
ISO 9001:2015

ELECTROLOG

electrolog

AS-PL products are present in prestigious catalogues

Catalogues, certificates and organisations



Products

Leader

32 years

**OF PREMIUM
QUALITY**

OF THE INDUSTRY

OF EXPERIENCE



POLAND

Headquarters

AS-PL Sp. z o.o.
ul. Michałki 32
80-716 Gdańsk, Poland

info@as-pl.com
+48 58 304 12 85

Sales Department

AS-PL Sp. z o.o.
Panattoni Park Gdańsk IV,
ul. Elbląska 130 / Building no. 2
80-718 Gdańsk, Poland

sales@as-pl.com
+48 58 304 12 85

Production Plant

AS-PL Sp. z o.o.
ul. Słoneczna 53
83-240 Lubichowo, Poland



UNITED KINGDOM

AS-PL UK Ltd.

Mersey Reach Logistics Park
Galgate Drive, UNIT 6A
L30 6AD Netherton, Bootle
Liverpool

uk@as-pl.com
+44 07748103736



ITALY

AS-PL ITALIA S.R.L.

Via Cavalieri del Lavoro 2/6
10024 Moncalieri (TO)
Italy

italia@as-pl.com

+39 347 444 2462

+39 011 198 00533



SPAIN

AS-PL ELECTRICOS ROTATIVOS S.L.

Carrer del Fuster 24
46988 Paterna, Valencia
Spain

espana@as-pl.com

+34 962 196 701

+34 619 960 026

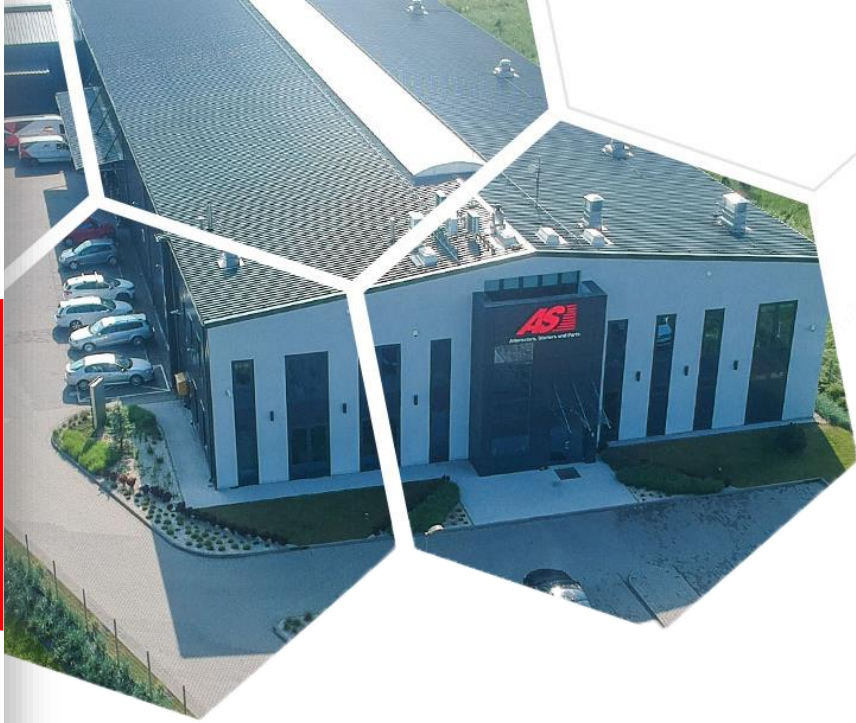

20 000 m²
of storage space

21 000

PALLET
PLACES

15 600

COMPLETED ORDERS
PER MONTH

89 700

DIFFERENT PRODUCTS
PACKED PER DAY



**We are a leader
in the alternator
and starter industry.
See what this means.**

PREMIUM QUALITY

All of our products are made of the best materials and assembled in our Production Facility. Before being delivered to the customer, they are subject to rigorous tests at numerous stages of production.

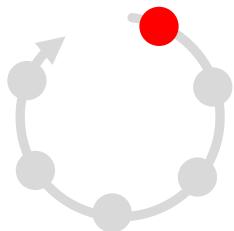

PRODUCT AVAILABILITY

More than **30,000** SKUs
in several warehouses and
1,000,000 corresponding
reference numbers.

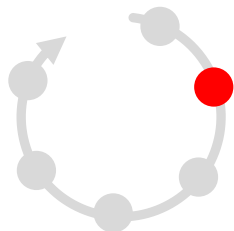

EU PRODUCTS

Our products are 100% made, assembled, and tested in our Production Facility located at the heart of the European Union.

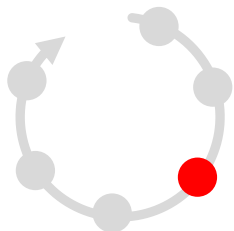

GREAT TEAM

More than **400** highly-qualified employees in several branches.

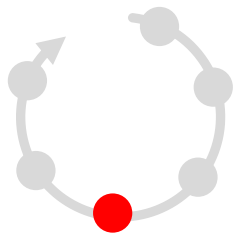

LARGE CHOICE

Our offer includes original parts and **AS**-brand substitutes at attractive prices. The product catalogue is constantly enhanced with new ones.

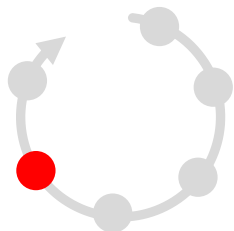

THE BEST SERVICE

World class customer service – customer-focused, helpful, quick to respond to any inquiries.

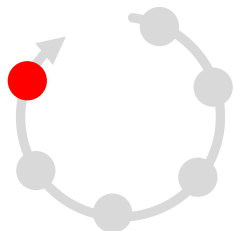



MODERN PURCHASE PLATFORM

Online store allowing you to place orders 24/7,
with numerous innovative features for buyers.





NO LOGIN REQUIRED

«« You can search and view products without the need to log in. »»

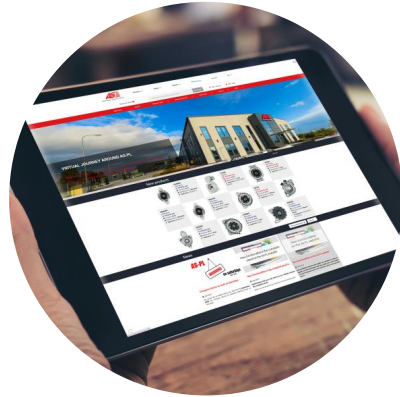

EXTENSIVE CATALOGUE

Clear, professional, and detailed catalogue on as-pl.com, available in many language versions.





MOBILE APPLICATION



The application can be downloaded in stores





INFORMATION AND FILTERS

Clear information about products on the website, export to PDF, advanced product search filters.



Generators, Starters & Parts

ELECTROLOG

electrolog

AS-PL products are present in prestigious catalogues

**TUV Rheinland
ISO 9001:2015**



MAM AutoCat v8



**TecDoc
DATA SUPPLIER**



We are also members of such organizations as:

SDCM



STOWARZYSZENIE
DYSTRYBUTORÓW
I PRODUCENTÓW
C Z E Ś C I
MOTORYZACYJNYCH



IAAF



APRA





WHAT IS IN THE OFFER?



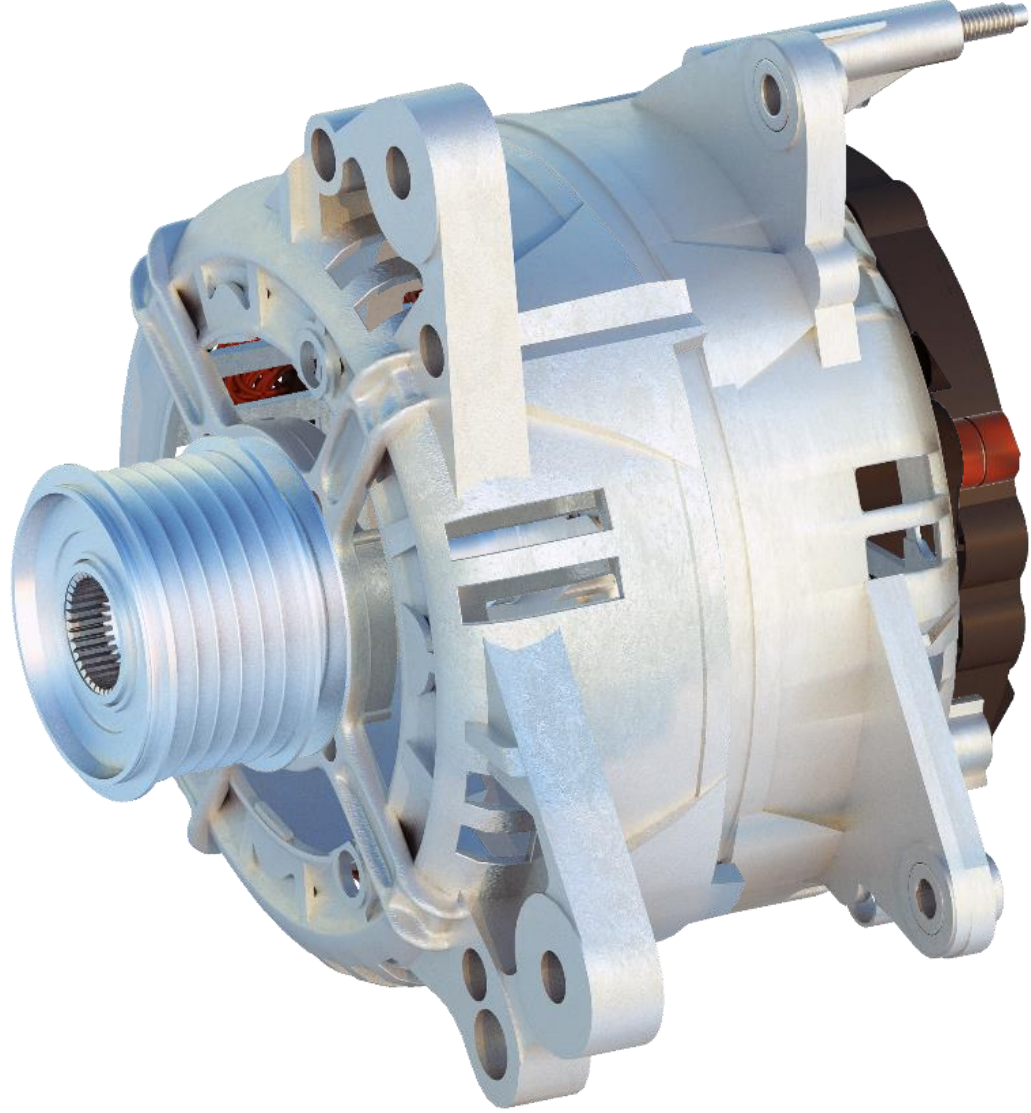

ALTERNATORS

ALTERNATOR

AS-PL has **more than 5,000** alternator types intended for:

- passenger cars,
- trucks,
- agricultural machinery,
- water vehicles,
- motorcycles,
- industrial machines.

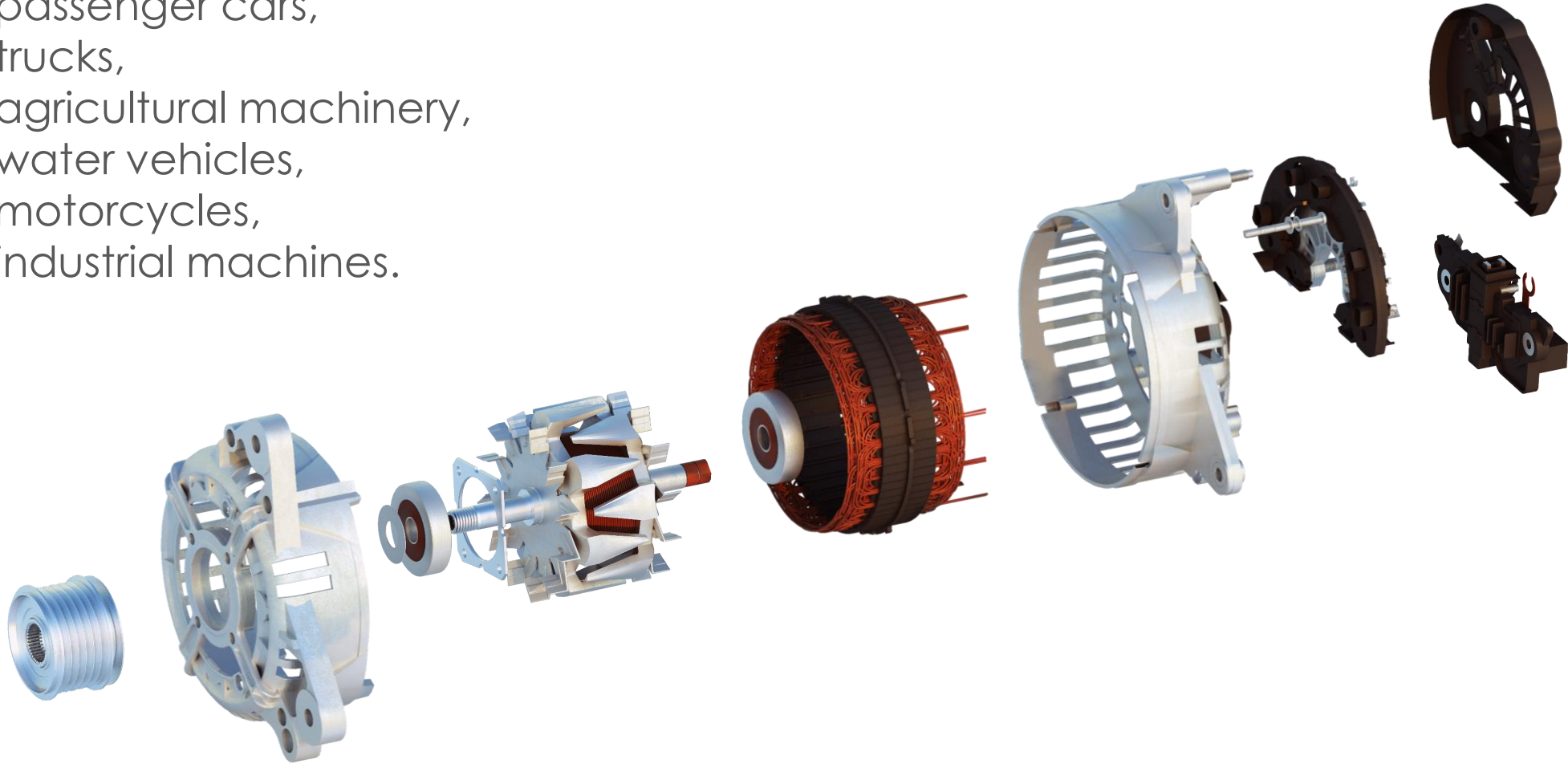

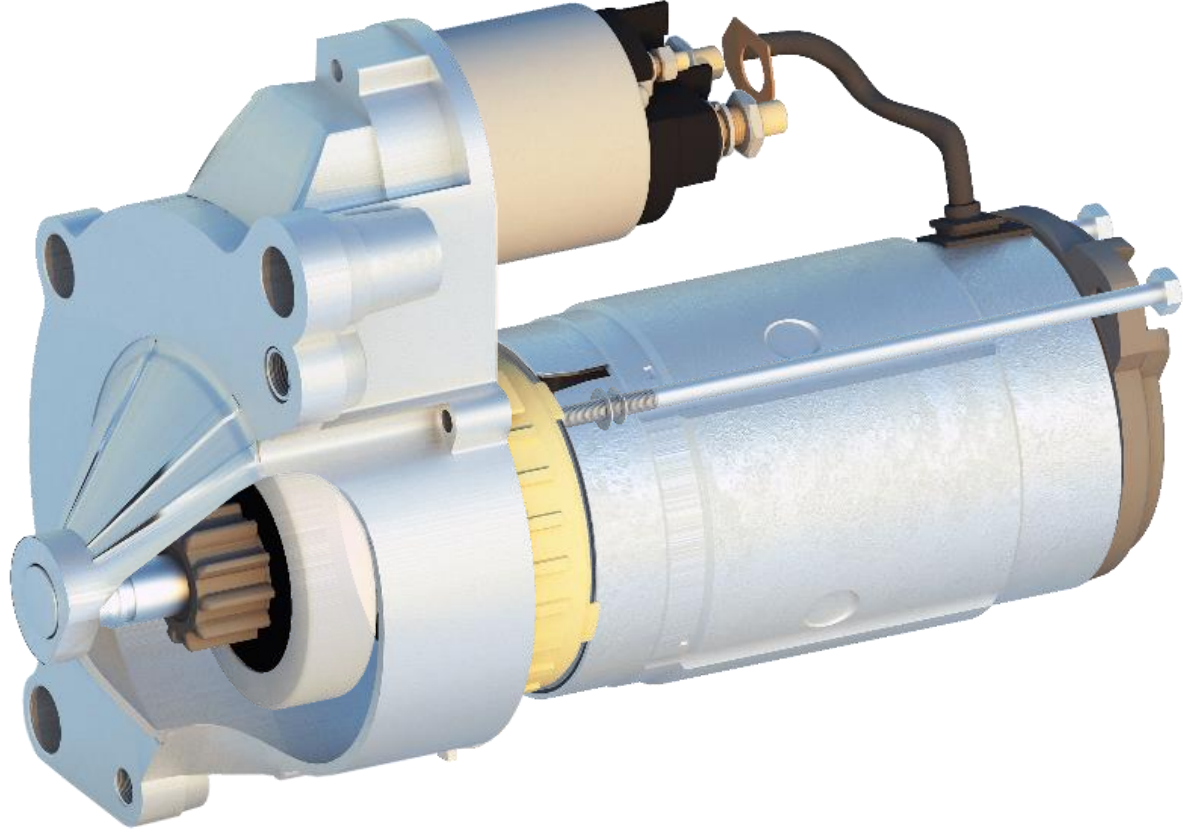

STARTERS

STARTER

AS-PL has **more than 4,700** starter types intended for:

- passenger cars,
- trucks,
- agricultural machinery,
- water vehicles,
- motorcycles,
- industrial machines.

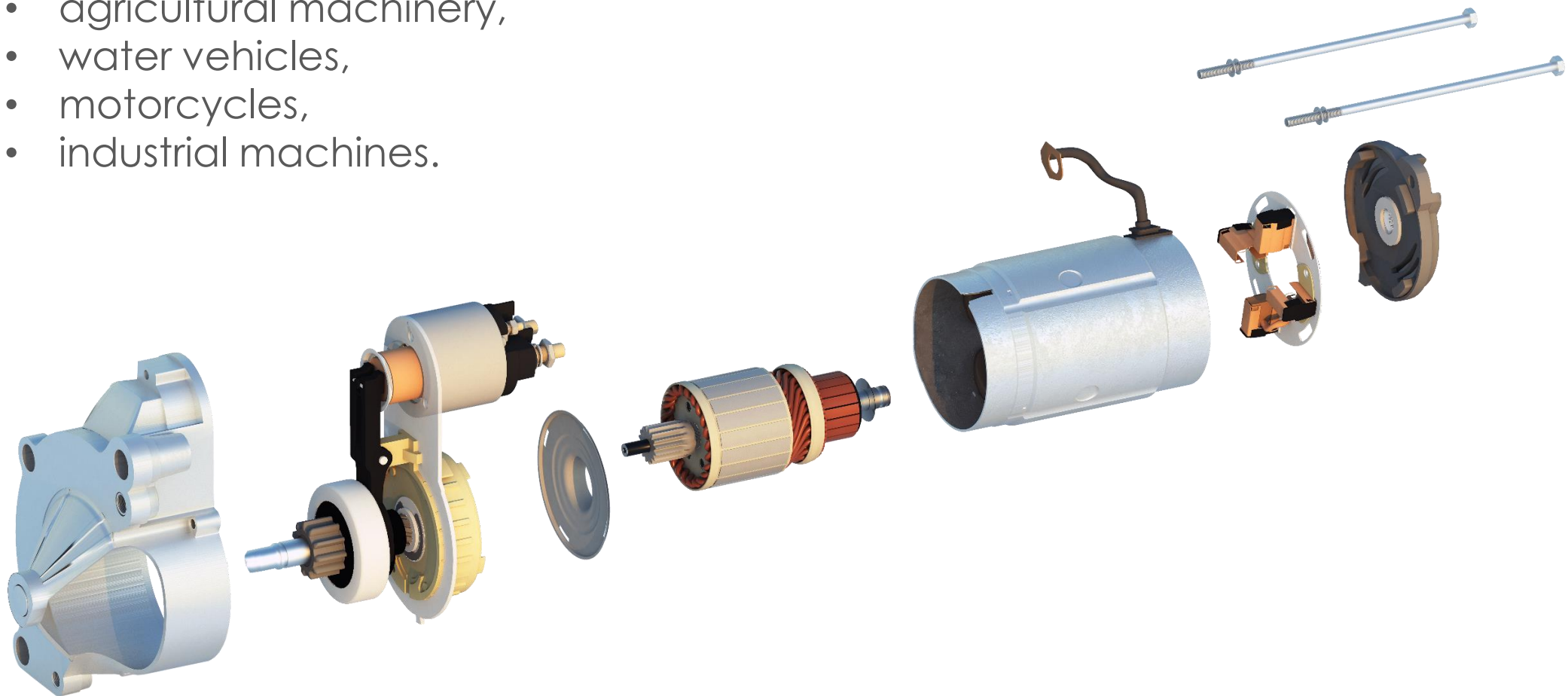

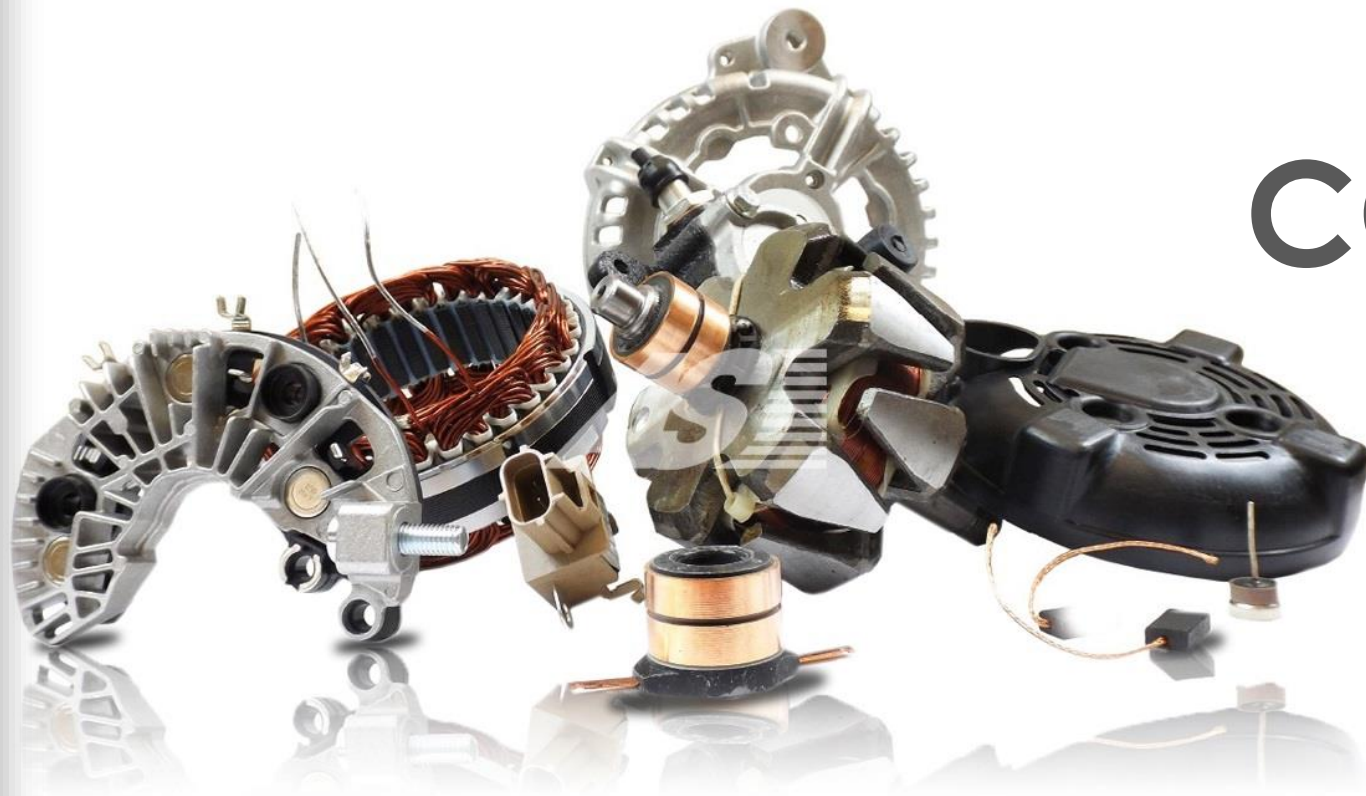

PARTS AND COMPONENTS



offer

PARTS AND COMPONENTS

AS-PL has **more than 20,000** parts and subassemblies. These include:

- ✓ alternator parts,
- ✓ starter parts,
- ✓ bearings and seals,
- ✓ ignition system components,
- ✓ other (machines and parts, gaskets, radial shaft seals, O-rings, brushes, etc.).

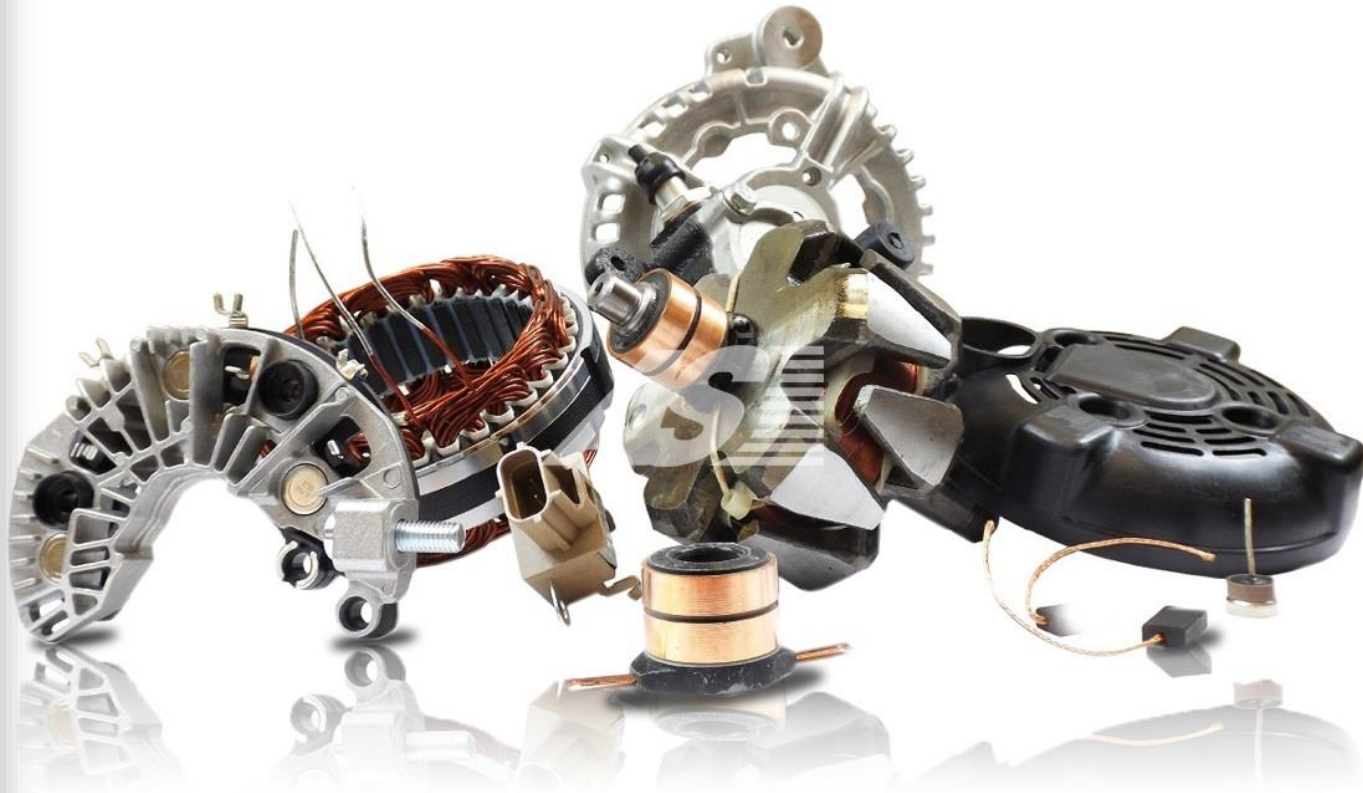



DIAGNOSTIC AND OTHER DEVICES



DIAGNOSTIC AND OTHER DEVICES



Our offer includes **diagnostic devices, machines**(manual point welders, high-power lead-free soldering stations, grit-blasting machine for cleaning metal elements), and **consumables**, and **direct-current motors**.



offer

activities

contact

advantages

remanufacturing

▶ Back



Premium Line



Standard Line



Economy Line

PRODUCT LINES



offer

91 % of our offer includes **AS**-brand products

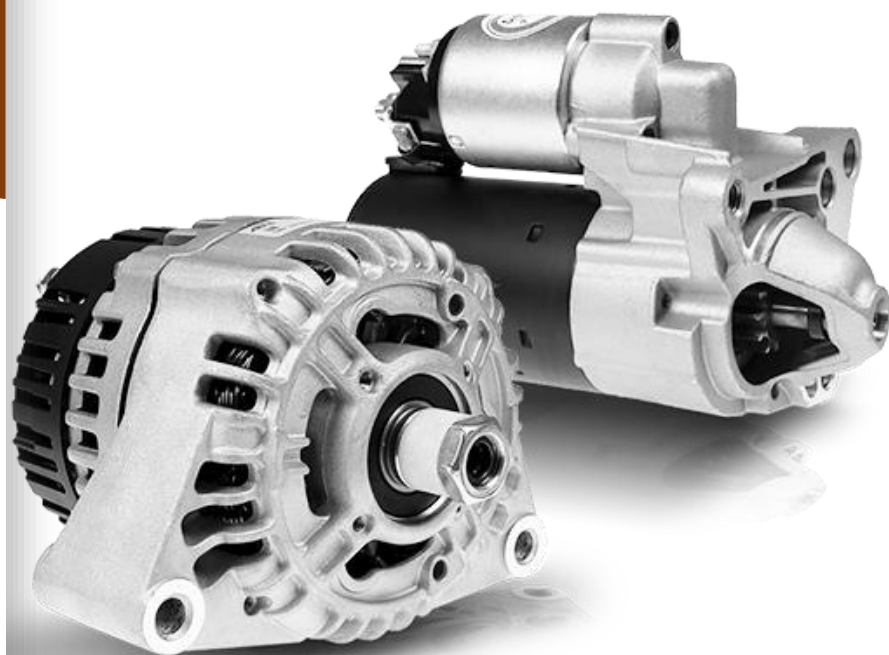

 **Premium Line** - the option addressed to the customers who are looking for the best quality. Products supplied by world-class OEM (Original Equipment Manufacturer) manufacturers and selected products of AS brand.

 **Standard Line** - the leading product line of the AS brand, option directed to the customers looking for high quality and reliable products at a competitive prices.

 **Economy Line** - the line of products that merge the quality at a reasonable price.



offer

activities

remanufacturing

advantages

contact

WHY CHOOSE REMANUFACTURED PRODUCTS?

HOW TO FIND THEM
On the AS-PL purchase platform, remanufactured products have the letter "R" at the end of their number.

COST ALTERNATIVE
Remanufactured products are an attractive cost alternative to buying new parts.

100% CONFIDENCE
A product that does not pass the final test is not sold, but subject to further verification to find the problem and remove it.

HIGH STANDARDS
The same standards apply as in the assembly of a new alternator or starter in an OEM factory.

SELECTION
Subject to remanufacturing are only carefully selected cores that meet specific standards and requirements.

DETAILED VERIFICATION
All products are disassembled and each part is subject to detailed verification. Useless subassemblies are disposed of in an environmentally-friendly way.

USED, AS NEW
All worn-out parts are replaced with new ones. Bearings and brushes are always replaced with new ones, regardless of their condition.

REFINEMENT AND COATING
Subassemblies are subject to a range of processes aimed at their refinement and protection.

ASSEMBLY
The product is assembled from the remanufactured and new parts. Then, it is subject to further tests.

FINAL TEST
The process ends with a final test and the result is delivered to the customer along with the product.



TECHNICAL ADVANTAGES

100% TESTED PRODUCTS

All the products are subject to rigorous tests before being delivered to the customer. Within one month, we carry out 75 thousand tests.

HIGHEST REQUIREMENTS

Our products meet the highest requirements in terms of assembly and technical parameters.

MODERN MACHINERY

Our Production Facility is equipped with professional machines, such as ones made by D&V Electronics, as well as our own innovative solutions.

FAILURE PREVENTION

All the painstaking tests performed at AS-PL allow us to prevent some of potential failures in the future.

LIKE OEM

A product remanufactured at the AS-PL Production Facility is no different to its OEM (Original Equipment Manufacturer) counterpart.

ONLY 0.75% COMPLAINTS

This is the value of complaints compared to the value of all our products sold within one year.

AT ONE PLACE

All the procedures related to the complaint process are carried out where the products are manufactured.

DETAILED VERIFICATION

All the products subject to the complaint procedure are carefully tested. If the product does not pass the tests, then the complaint is accepted.

CONSTANT IMPROVEMENT

Based on the most frequent causes of accepted complaints, we make decisions relating to any possible changes in the product manufacturing process or the product design.

ECONOMICAL AND ECOLOGICAL ADVANTAGES

ECONOMICAL ALTERNATIVE

Remanufactured products are a cost-effective alternative to buying new parts.

PLENTY OF TESTS

The range of tests that all our products are subject to reduces the number of potential returns.

ATTRACTIVE PRICES

All the processes are optimized to offer the best possible prices of the products.

PROTECTED PRODUCTS

Before shipment to the customer, products are carefully packed and properly protected against any damage.

MORE THAN 80% OF ORIGINAL PARTS

Premium line products have more than 80% of original parts on average.

VALUABLE RESOURCES

Our remanufacturing method at AS-PL allows saving valuable mineral resources as well as power and water.

WASTE MINIMISATION

During the remanufacturing process, we use as many parts from the remanufactured product as possible, which considerably reduces its price.



remanufacturing

offer

activities



Alternators, Starters & Parts



Sales Department
Tel. (+48) 58 304 12 85



sales@as-pl.com
as-pl.com



advantages

remanufacturing

offer

activities